

MAGNASPHERE MSS-300S SERIES INSTALLATION INSTRUCTIONS: All Models of MSS300S-Series

Required Tools and Components

Provided by Manufacturer (per module set)

- 1 MSS-3XXS switch module
- 1 MSS-3XXS magnet module

Provided by Installer

- Power drill
- #36 Drill Bit or 7/64
- 4 #8 (x7/8" MIN) Flat Head Screws

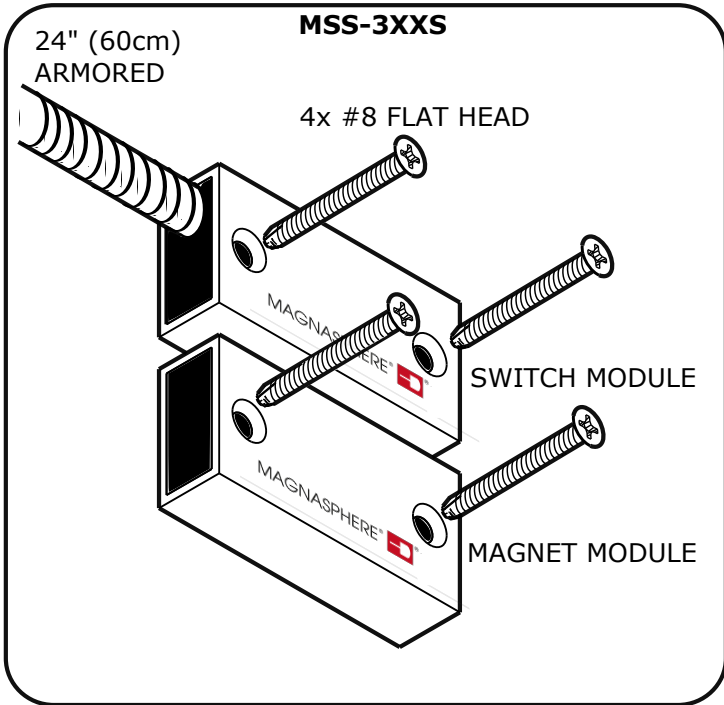

Specifications

Max Current: 0.25 A Resistive
Max Voltage: 30 VDC
Max Power: .25 W Resistive
 The Magnasphere MSS-3XXS series is intended to be connected to a UL Listed compatible control panel for US applications and a ULC Listed compatible control panel for Canadian applications.

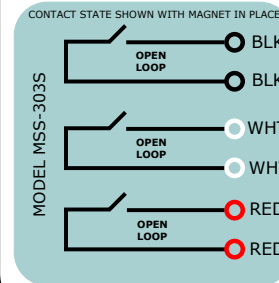
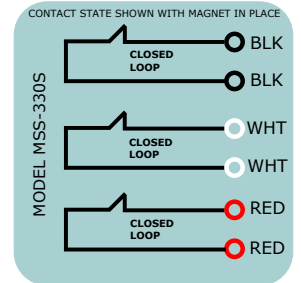

NOMENCLATURE

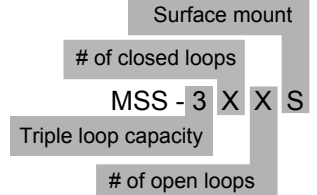

Installation Plan & Switch Orientation

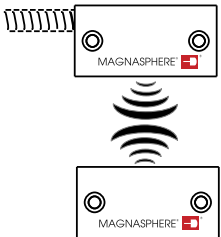

Note: Modules are sensitive in one direction. Logos indicate the proper orientation as illustrated.

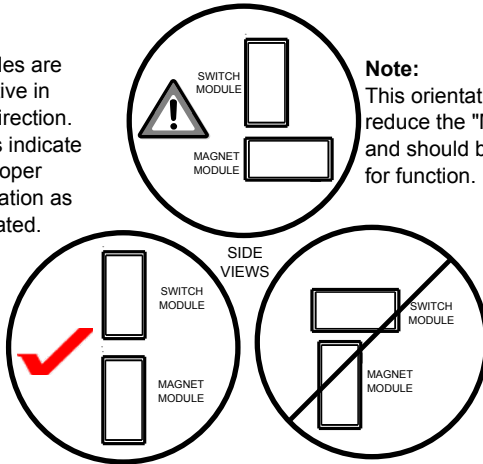

Note: This orientation will reduce the "MAX GAP" and should be tested for function.

Installation:

The 3xxS should be mounted close to the latch side of the door for optimal performance. In order to meet UL 681 requirements, contact shall be installed so door cannot be opened more than 2 inches without causing an alarm. Intended for operating gaps of up to 5/16" (8mm). Ensure that the modules are well aligned. When synchronous switching of the contacts is important, position modules to operate as depicted.* Hold the switch module in position and drill one pilot hole; drive the #8 screw in until the module is seated. Repeat for the second hole. Repeat these steps for the magnet module to insure accurate positioning. Wire the switch according to the schematic. Check the operation of the installed switch.

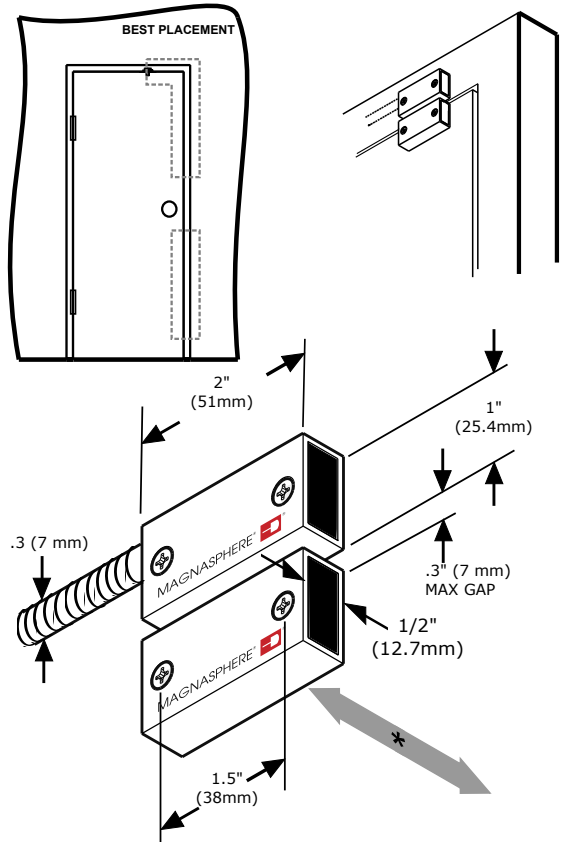

Patents #5673021, #6603378 & Patents Pending

03-2012-MSS-300S INST-DRAFT

