



High Performance Bi-Directional Digital MEMS Gas Flow Sensor

MFC2000 Series

FEATURES

- Bi-directional flow (± 30 or ± 70 SLM)
- High dynamic range
- $\pm 3\%$ m.v. accuracy
- $\pm 0.8\%$ m.v. repeatability
- Low power consumption
- Fast response time
- Single 2.7 - 5.5Vdc power supply
- Digital I²C and analog outputs
- Standard push-in fitting sizes
- Custom fluid connector available
- Temperature compensated
- Highly configurable firmware
- Easy-to-use PC-based GUI
- RoHS and WEEE compliant

APPLICATIONS

- Medical gas flow measurement and control
- Industrial gas flow measurement and control
- Consumer products

DESCRIPTION

MFC2000 series is a new gas flow sensing module platform based on MEMSIC's proprietary CMOS technology for thermal mass flow sensing. It can measure up to 70 SLM bi-directional flow rate with +/- 3.0% accuracy.

The sensing element is monolithically integrated with CMOS signal processing circuitry and embedded software capable of converting gas flow rates to a digital or analog output with very high repeatability. The module has very low operating power consumption (< 5 mA) and a low power consumption sleep mode (<100 μ A) for optimal power management in portable applications. The MFC2000 series is



MFC2030 ± 30 SLM version.

externally powered, up to 5.5V (3.3V typ.). I²C digital output is standard. Other output available upon request.

The MFC2000 series includes firmware that is highly configurable, offering the user a variety of settings that can be tailored to specific applications. This includes data output type, calibration settings, measurement modes, and power consumption. A user-friendly PC-based application offers the user a variety of data collection options, including real-time graphical display. Mechanically, the unit includes fittings that can accept a variety of standard inlet tube sizes.

MFC2000 series is a true thermal mass flow sensing module, and can easily be configured to suit a variety of applications, from medical flow to industrial processing. Customized versions, including customer specific bulk channel and mounting options are available.

For more information, please contact MEMSIC at info@memsic.com.

Information furnished by MEMSIC is believed to be accurate and reliable. However, no responsibility is assumed by MEMSIC for its use, or for any infringements of patents or other rights of third parties, which may result from its use. No license is granted by implication or otherwise under any patent or patent rights of MEMSIC.

©MEMSIC, Inc.
One Technology Drive, Suite 325, Andover, MA 01810, USA
Tel: +1 978 738 0900 Fax: +1 978 738 0196

www.memsic.com

SENSOR CHARACTERISTICS

(Measurements performed with air at 23°C temperature, 1 Atm pressure, 50% RH, at 5.0V DC power supply, unless otherwise specified). Calibration conditions for standard liters per minute slm: 20°C, 1013mbar.

Parameter	Condition	30 SLM	70 SLM	Unit
Measurement Range	Straight/Manifold Mounting	+/- 30	+/- 70	SLM
Flow Direction		Bi-directional		N/A
Supply DC Voltage (VDD)		2.7 – 5.5		Vdc
Interface Voltage ¹ (VDDIO)	(See note 1)	2.7 – 3.0		V
Output Range	I2C Mode ²	0 – 65,535		LSB
	PWM Analog Mode	0 – VDDIO		Vdc
Operating Temperature		(20) – 80		°C
Calibrated Temperature		0 – 50		°C
Storage Temperature		(40) – 85		°C
Relative Humidity	non-condensing	0 – 95		%
Supply Current ³	Operating mode	5		mA
	Sleep mode	100		µA
Accuracy ⁴	$0.01Q_{max} \leq Q < Q_{max}$	3.0		% m.v.
	$Q < 0.01Q_{max}$	0.03		% F.S.
Repeatability ⁵	ODR = 100Hz	$0.1Q_{max} \leq Q \leq Q_{max}$	0.8	% m.v.
		$Q < 0.1Q_{max}$	0.08	% F.S.
	ODR = 10Hz	$0.1Q_{max} \leq Q \leq Q_{max}$	0.3	% m.v.
		$Q < 0.1Q_{max}$	0.03	% F.S.
RMS Noise at Zero Flow	ODR = 100Hz	25		sccm
	ODR = 10Hz	8		sccm
Offset Shift w/Temp.	0 - 50°C	2		SCCM/°C
Total Error Band ⁴	0 - 50°C, $0.1Q_{max} \leq Q \leq Q_{max}$	3.5		% m.v.
Pressure Drop	Q_{max}	4	18	mbar
Sample Rate		10		msec
Orientation Sensitivity		< 60		sccm
Wake Time	Wake up from sleep mode	40		msec
Working Pressure		0 - 8		Bar
Module Weight	Includes aluminum inserts	< 100		g
Wetted Material	Si, SiO ₂ , Si ₃ N ₄ , Aluminum, PPSU, Stainless steel, Viton, Nitrile rubber, Aluminum alloy 3003, Epoxy, Silicone			

Note 1: VDDIO is generated internally and should be used to set the logic high voltage for I²C interface. VDDIO can supply a current up to 100 mA.

Note 2: Use two's complement as binary signed number representation.

Note 3: Power consumption can be optimized using "Power-Cycle" configuration to program the wake and sleep duration.

Note 4: Accuracy is defined as the sum of all dc errors (linearity) at 23°C. Error Band is defined as the sum of accuracy and offset/span due to temperature. Both are measured after factory calibration, using internal averaging (100x) to eliminate errors due to noise. If the end application requires a high Output Data Rate (ODR), and cannot benefit from averaging, the total RMS error of any given measurement can be calculated by adding the repeatability specification.

Note 5: Repeatability is defined as standard deviation divided by mean flow (% m.v.), or standard deviation divided by F.S. (% F.S.). Average/ODR is programmable.

ABSOLUTE MAXIMUM RATINGS*

- Supply Voltage (V_{DD}) 2.7 to +5.5V
- Storage Temperature-40°C to +85°C
- Pressure0 - 8 Bar Gauge
- Shock 10g, 0.5ms
- Vibration 1g, 5 to 200 Hz
- ESD 4kV/8kV (contact/air discharge)

Note: Stresses above those listed under Absolute Maximum Ratings may cause permanent damage to the device. This is a stress rating only; the functional operation of the device at these or any other conditions above those indicated in the operational sections of this specification is not implied. Exposure to absolute maximum rating conditions for extended periods may affect the device’s reliability.

CONFIGURATION AND MARKING

Pinout Configuration:

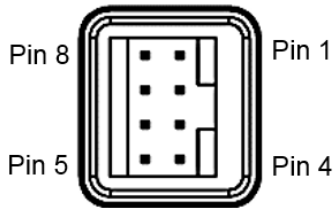

MFC2030 pin configuration.

Pin	Name	Description
1	VDD	Power Supply
2	VDDIO	I/O Voltage Reference
3	SCL	Serial Clock Line for I ² C bus
4	SDA	Serial Data Line for I ² C bus
5	GND	Connect to Ground
6	GND	Connect to Ground
7	GND	Connect to Ground
8	VOUT/INT	PWM Analog Output (default) or Interrupt Output (data ready)

Marking Illustration:

- Line 1: The arrow sign of MEMSIC Logo denotes the positive direction of flow
- Line 2: Model name
- Line 3: Barcode (shown below as a space)
- Line 4: Lot number



THEORY OF OPERATION

The flow rate is detected by the MEMS thermal mass flow sensor. The sensor chip, produced in MEMSIC proprietary CMOS compatible technology, is composed of a central heater source (micro heater) and two temperature sensors (thermopiles), which are placed symmetrically upstream and downstream of the micro-heater. If no gas flows over the sensor surface, the symmetric thermopiles measure the same rise in temperature, resulting in the same output voltage of the two thermopiles. If a non-zero gas flows from the inlet to the outlet of the meter, the velocity of a fully-developed laminar air flow unbalances the temperature profile around the heater and heat is transferred from upstream thermopiles to the downstream thermopiles, causing a change in the voltages of the thermopiles. Larger gas flow rates result in larger asymmetry in the profile.

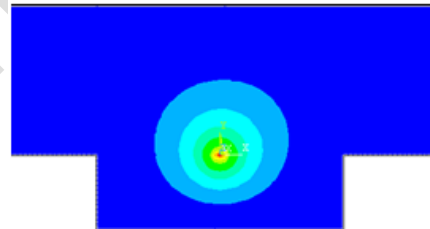

Zero gas flow.

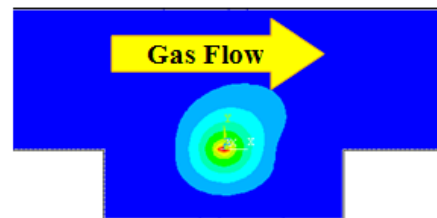

Non-zero gas flow.

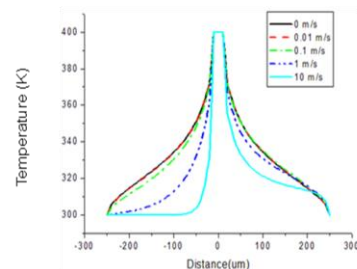

Temp. profiles vs. distances/gas velocities.

PACKAGE DRAWING

The MEMSIC MFC2000 series Mass Flow Meter is mounted in chemically inert filled PPSU housing (available in other material, see “Order Information”). The physical dimensions, mounting information and pin layout are provided below. A push-in tube fitting or a PPSU flange (manifold mounting) is provided on inlet and outlet sides of the module for flow connection. For electrical connection, an 8-pin male header (FCI 69168-108HLF) is provided on the top side of the module for I²C interface connection. The recommended mechanical/electrical connectors are shown as follows. The unit can be printed circuit board mounted is needed.

Recommended Connector		Example
Flow Fitting	Push-in connector included	See “Ordering Information”
Electrical	8 pin crimp to wire housing (2.54mm pitch, 2 rows, 2.54mm row space)	FCI 65846-016LF
O-ring (Manifold Mounting)	ID: 17mm, Width: 1mm	

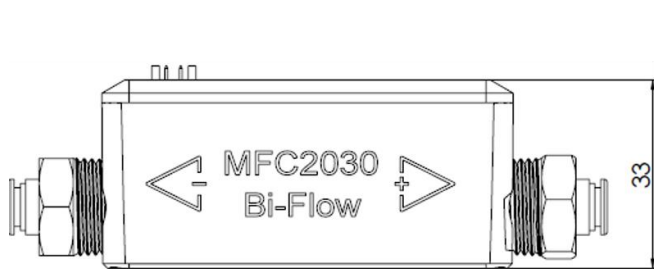

Side view dimension

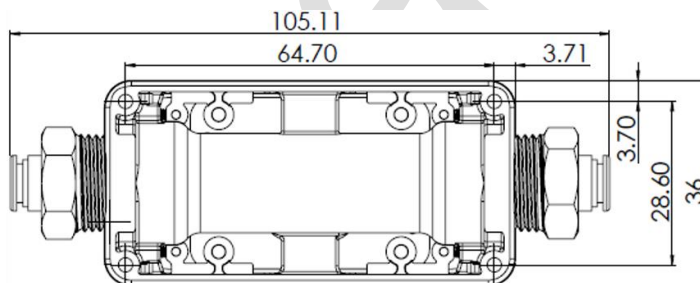

Bottom view dimension



Polycarbonate housing with straight plug-in fitting for industrial application

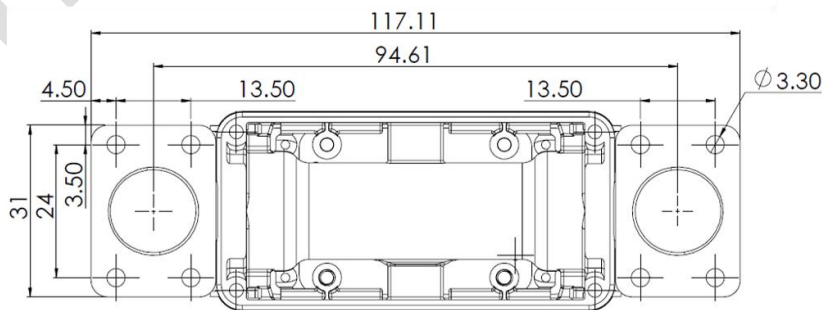

Bottom view dimension – manifold mount

MFC2000 module mechanical dimensions (in mm).

ORDERING INFORMATION

Options	Ranges		Calibration		Housing Material		Tube OD	
MFC	2030	30 SLM	B	Bi-Directional	P	PPSU	1	6 mm
	2070	70 SLM	U	Uni-Directional	T	Aluminum	2	1/4 Inch
					C	Polycarbonate	3	10 mm
							4	3/8 Inch
							5	Manifold Mount
	Gas		I2C Address					
	N	Air/N ₂	1	0x31 (preferred)				
	X	O ₂	2	0x21				
	C	CO ₂	3	0x23				
	R	Ar	4	0x33				
	M	CH ₄	5	0x35				
			6	0x41				
			7	0x43				
			8	0x45				