

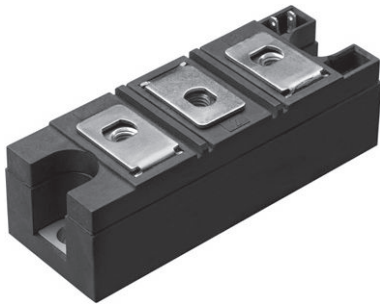

INT-A-PAK Power Module Thyristor/Diode, 300 A

INT-A-PAK

FEATURES

- Electrically isolated base plate
- 3000 V_{RMS} isolating voltage
- Industrial standard package
- Simplified mechanical designs, rapid assembly
- High surge capability
- Large creepage distances
- UL approved file E78996 
- Material categorization: For definitions of compliance please see www.vishay.com/doc?99912

RoHS
COMPLIANT

APPLICATIONS

- Battery chargers
- Welders
- Power converters
- Alternators

PRODUCT SUMMARY	
I _{T(AV)}	300 A
Type	Modules - Thyristor, Standard
Package	INT-A-PAK
Circuit	SCR/diode doubler circuit, negative control

MAJOR RATINGS AND CHARACTERISTICS			
SYMBOL	CHARACTERISTICS	VALUES	UNITS
V _{DRM} /V _{RRM}		800	V
I _{T(AV)}	53 °C	300	A
I _{TSM}	50 Hz	6500	A
	60 Hz	6900	
I ² t	50 Hz	214	kA ² s
	60 Hz	195	
I ² √t		2140	kA ² √s
T _J	Range	-40 to 140	°C

ELECTRICAL SPECIFICATIONS

VOLTAGE RATINGS			
TYPE NUMBER	V _{RRM} /V _{DRM} , MAXIMUM REPETITIVE PEAK REVERSE VOLTAGE V	V _{RSM} /V _{DSM} , MAXIMUM NON-REPETITIVE PEAK REVERSE VOLTAGE V	I _{RRM} /I _{DRM} AT 125 °C mA
VS-VSKL300/08PbF	800	900	50



ON-STATE CONDUCTION					
PARAMETER	SYMBOL	TEST CONDITIONS		VALUES	UNITS
Maximum average on-state current at case temperature	$I_{T(AV)}$	180° conduction half sine wave		300	A
				53	°C
Maximum RMS on-state current	$I_{T(RMS)}$	As AC switch		116	A
Maximum peak, one-cycle on-state, non-repetitive surge current	I_{TSM}	t = 10 ms	No voltage reappplied	6600	
		t = 8.3 ms		6900	
		t = 10 ms	100 % V_{RRM} reappplied	5500	
		t = 8.3 ms		5800	
Maximum I^2t for fusing	I^2t	t = 10 ms	No voltage reappplied	214	
		t = 8.3 ms		195	
		t = 10 ms	100 % V_{RRM} reappplied	151	
		t = 8.3 ms		138	
Maximum $I^2\sqrt{t}$ for fusing	$I^2\sqrt{t}$	t = 0.1 ms to 10 ms, no voltage reappplied		2140	kA ² √s
Low level value of threshold voltage	$V_{T(TO)1}$	(16.7 % $\times \pi \times I_{T(AV)} < I < \pi \times I_{T(AV)}$), T_J maximum		0.796	V
High level value of threshold voltage	$V_{T(TO)2}$	(I > $\pi \times I_{T(AV)}$), T_J maximum		0.868	
Low level value on-state slope resistance	r_{t1}	(16.7 % $\times \pi \times I_{T(AV)} < I < \pi \times I_{T(AV)}$), T_J maximum		0.972	mΩ
High level value on-state slope resistance	r_{t2}	(I > $\pi \times I_{T(AV)}$), T_J maximum		0.88	
Maximum on-state voltage drop	V_{TM}	$T_J = 25\text{ °C}$, 500 A I_{pk}	SCR	1.35	V
	V_{FM}		DIODE	1.20	

SWITCHING					
PARAMETER	SYMBOL	TEST CONDITIONS		VALUES	UNITS
Typical delay time	t_d	Gate current 1 A, $dI_g/dt = 1\text{ A}/\mu\text{s}$ $V_d = 0.67\% V_{DRM}$, $T_J = 25\text{ °C}$		1.0	μs
Typical turn-off time	t_q	$I_{TM} = 300\text{ A}$, $T_J = T_J$ maximum, $dI/dt = 20\text{ A}/\mu\text{s}$, $V_R = 50\text{ V}$ $dV/dt = 20\text{ V}/\mu\text{s}$, Gate 0 V 100 Ω, $t_p = 500\text{ μs}$		100	

BLOCKING					
PARAMETER	SYMBOL	TEST CONDITIONS		VALUES	UNITS
Maximum critical rate of rise of off-state voltage	dV/dt	$T_J = T_J$ maximum linear to 67 % rated V_{DRM}		500	V/μs
Maximum peak reverse and off-state leakage current	I_{DRM} , I_{RRM}	$T_J = T_J$ maximum, rated V_{DRM}/V_{RRM} applied		50	mA
RMS insulation voltage	V_{INS}	50 Hz, circuit to base, all terminal shorted, t = 1 s		3000	V



TRIGGERING				
PARAMETER	SYMBOL	TEST CONDITIONS	VALUES	UNITS
Maximum peak gate power	P_{GM}	$T_J = T_J$ maximum, $t_p \leq 5$ ms	10.0	W
Maximum average gate power	$P_{G(AV)}$	$T_J = T_J$ maximum, $f = 50$ Hz, $d\% = 50$	2.0	
Maximum peak positive gate current	I_{GM}	$T_J = T_J$ maximum, $t_p \leq 5$ ms	3.0	A
Maximum required DC gate voltage to trigger	V_{GT}	$T_J = 25$ °C Anode supply: 12 V resistive load	3	V
Maximum required DC gate current to trigger	I_{GT}		200	mA
Maximum holding current	I_H		600	
Maximum peak positive gate voltage	$+V_{GM}$	$T_J = T_J$ maximum, $t_p \leq 5$ ms	20	V
Maximum peak negative gate voltage	$-V_{GM}$		5.0	
DC gate voltage not to trigger	V_{GD}	$T_J = T_J$ maximum Maximum gate current/voltage not to trigger is the maximum value which will not trigger any unit with rated V_{DRM} anode to cathode applied	0.30	V
DC gate current not to trigger	I_{GD}		10	mA
Maximum non-repetitive rate of rise of turned-on current	di/dt	Gate drive 20 V, 20 Ω , $t_r \leq 1$ μ s $T_J = T_J$ maximum, anode voltage $\leq 80\%$ V_{DRM}	1000	A/ μ s

THERMAL AND MECHANICAL SPECIFICATIONS				
PARAMETER	SYMBOL	TEST CONDITIONS	VALUES	UNITS
Maximum junction operating temperature range	T_J		-40 to 140	°C
Maximum storage temperature range	T_{Stg}		-40 to 150	
Maximum thermal resistance, junction to case per junction	R_{thJC}	DC operation	0.19	K/W
Maximum thermal resistance, case to heatsink per module	R_{thCS}	Mounting surface smooth, flat and greased	0.035	
Mounting torque $\pm 10\%$	IAP to heatsink	A mounting compound is recommended and the torque should be rechecked after a period of 3 hours to allow for the spread of the compound. Lubricated threads.	4 to 6	Nm
	busbar to IAP			
Approximate weight			500	g
			17.8	oz.
Case style				INT-A-PAK

ΔR CONDUCTION PER JUNCTION											
DEVICES	SINUSOIDAL CONDUCTION AT T_J MAXIMUM					RECTANGULAR CONDUCTION AT T_J MAXIMUM					UNITS
	180°	120°	90°	60°	30°	180°	120°	90°	60°	30°	
VSKL300	0.019	0.022	0.028	0.041	0.068	0.013	0.023	0.031	0.043	0.069	K/W

Note

- Table shows the increment of thermal resistance R_{thJC} when devices operate at different conduction angles than DC

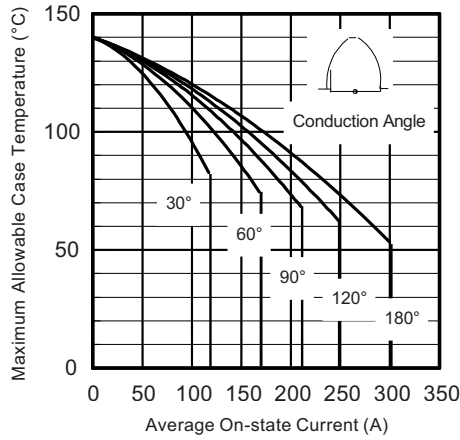

Fig. 1 - Current Ratings Characteristics

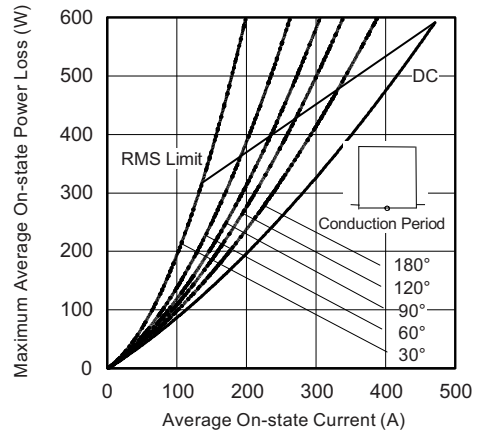

Fig. 4 - On-State Power Loss Characteristics

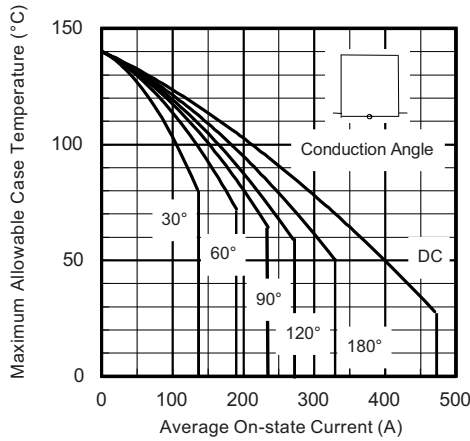

Fig. 2 - Current Ratings Characteristics

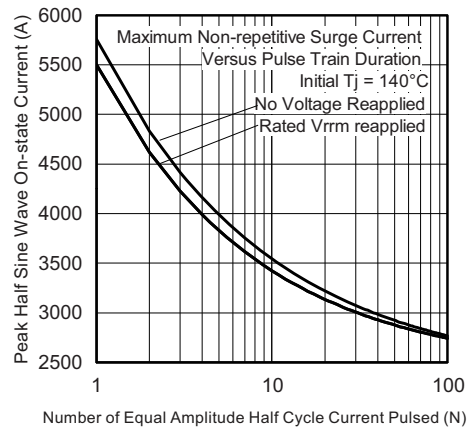

Fig. 5 - Maximum Non-Repetitive Surge Current

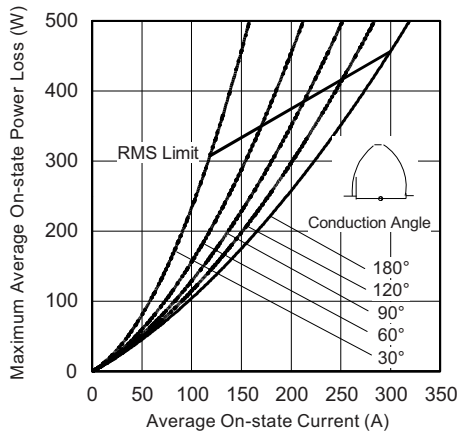

Fig. 3 - On-State Power Loss Characteristics

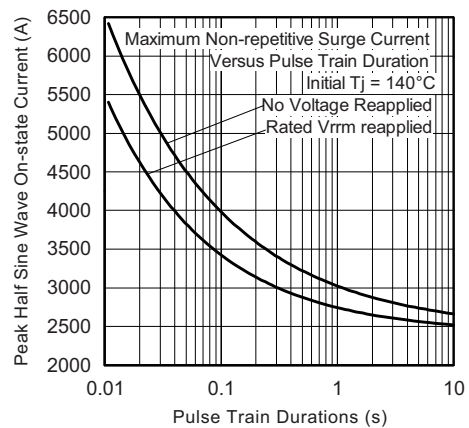

Fig. 6 - Maximum Non-Repetitive Surge Current

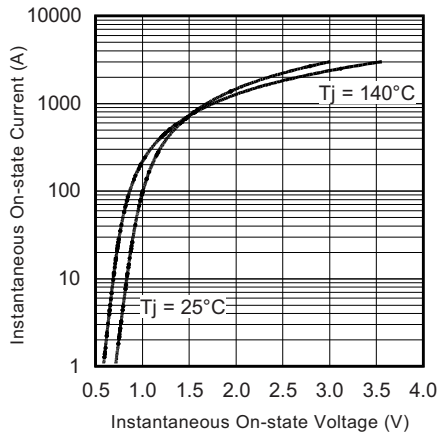

Fig. 7 - On-State Voltage Drop Characteristics (SCR)

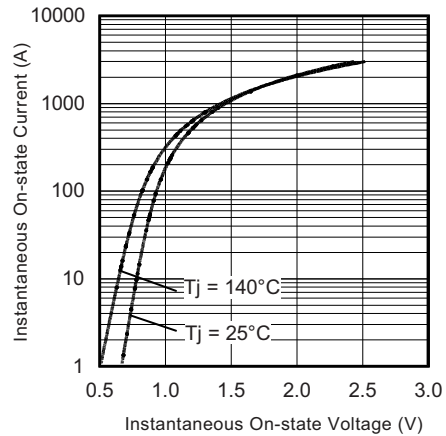

Fig. 8 - On-State Voltage Drop Characteristics (Diode)

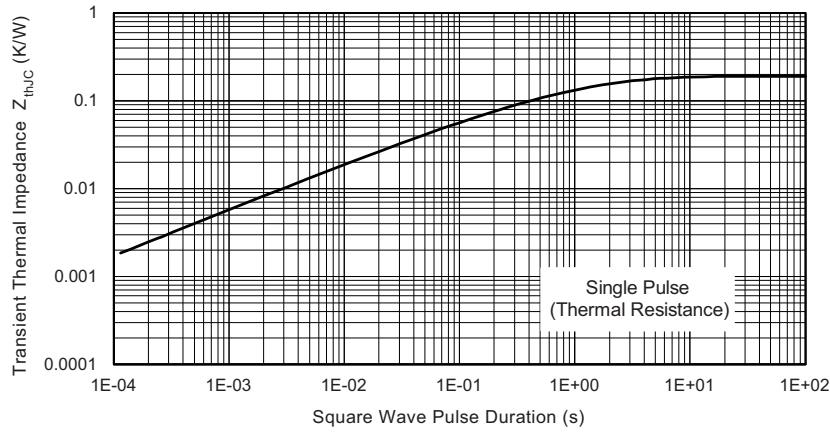

Fig. 9 - Thermal Impedance Z_{thJC} Characteristics

ORDERING INFORMATION TABLE

Device code	VS-VS	KL	300	08	PbF
	①	②	③	④	⑤
	1	-	Vishay Semiconductors product		
	2	-	Circuit configuration		
	3	-	Current rating (300 = 300 A)		
	4	-	Voltage rating (08 = 800 V)		
	5	-	PbF = Lead (Pb)-free		



CIRCUIT CONFIGURATION		
CIRCUIT DESCRIPTION	CIRCUIT CONFIGURATION CODE	CIRCUIT DRAWING
SCR/diode doubler circuit, negative control	L	

LINKS TO RELATED DOCUMENTS	
Dimensions	www.vishay.com/doc?95010

INT-A-PAK Diode

DIMENSIONS in millimeters (inches)

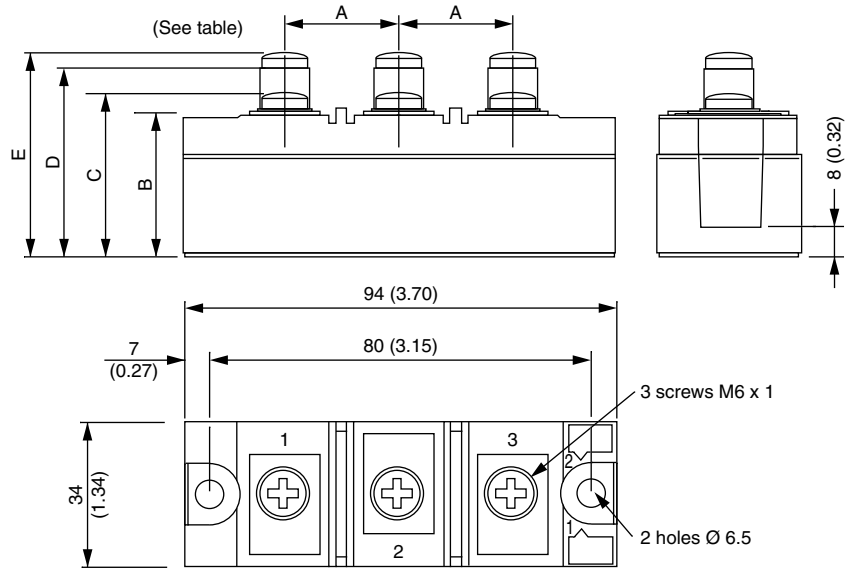

A	B	C	D	E
23 (0.91)	30 (1.18)	36 (1.42)	-	-



Disclaimer

ALL PRODUCT, PRODUCT SPECIFICATIONS AND DATA ARE SUBJECT TO CHANGE WITHOUT NOTICE TO IMPROVE RELIABILITY, FUNCTION OR DESIGN OR OTHERWISE.

Vishay Intertechnology, Inc., its affiliates, agents, and employees, and all persons acting on its or their behalf (collectively, "Vishay"), disclaim any and all liability for any errors, inaccuracies or incompleteness contained in any datasheet or in any other disclosure relating to any product.

Vishay makes no warranty, representation or guarantee regarding the suitability of the products for any particular purpose or the continuing production of any product. To the maximum extent permitted by applicable law, Vishay disclaims (i) any and all liability arising out of the application or use of any product, (ii) any and all liability, including without limitation special, consequential or incidental damages, and (iii) any and all implied warranties, including warranties of fitness for particular purpose, non-infringement and merchantability.

Statements regarding the suitability of products for certain types of applications are based on Vishay's knowledge of typical requirements that are often placed on Vishay products in generic applications. Such statements are not binding statements about the suitability of products for a particular application. It is the customer's responsibility to validate that a particular product with the properties described in the product specification is suitable for use in a particular application. Parameters provided in datasheets and / or specifications may vary in different applications and performance may vary over time. All operating parameters, including typical parameters, must be validated for each customer application by the customer's technical experts. Product specifications do not expand or otherwise modify Vishay's terms and conditions of purchase, including but not limited to the warranty expressed therein.

Except as expressly indicated in writing, Vishay products are not designed for use in medical, life-saving, or life-sustaining applications or for any other application in which the failure of the Vishay product could result in personal injury or death. Customers using or selling Vishay products not expressly indicated for use in such applications do so at their own risk. Please contact authorized Vishay personnel to obtain written terms and conditions regarding products designed for such applications.

No license, express or implied, by estoppel or otherwise, to any intellectual property rights is granted by this document or by any conduct of Vishay. Product names and markings noted herein may be trademarks of their respective owners.